

ALTEA 360/500 LED

astro

8014 / SKU 1133005

8015 / SKU 1133006

GB Products with electronic ballasts / drivers must not be installed on the same electrical circuits as products with inductive loads, for example magnetic fluorescent luminaires, motors or ventilators. Inductive loads can generate excessive voltage surges which can damage electronic ballasts.

PLEASE READ THE INSTRUCTIONS CAREFULLY BEFORE COMMENCING ASSEMBLY

Live: Normally Brown / Red
Neutral: Normally Blue / Black
Earth: Normally Green / Yellow

The light source of this luminaire is NOT replaceable; when the light source reaches its end of life the whole luminaire shall be replaced.

FR Les luminaires utilisant un ballast électronique / drivers ne peuvent être installés sur le même circuit que des appareils avec charges inductives, tels que luminaires fluorescents magnétiques, moteurs et ventilateurs. Les charges inductives peuvent générer des voltages excessifs et ainsi endommager les ballasts électroniques.

LIRE ATTENTIVEMENT LES INSTRUCTIONS AVANT DE COMMENCER LE MONTAGE

Phase: Normalement Brun / Rouge
Neutre: Normalement Bleu / Noir
Terre: Normalement Vert / Jaune

La source lumineuse de ce luminaire n'est pas remplaçable ; lorsque la source lumineuse atteint la fin de sa durée de vie le luminaire complet doit être remplacé.

IT Tutti i prodotti che includono ballast elettronici non devono essere installati sugli stessi circuiti elettrici come anche prodotti con carichi induttivi quali lampadari a fluorescenza magnetica, motori o ventilatori. I carichi induttivi possono generare scariche eccessive che possono danneggiare i ballast.

LEGGERE ATTENTAMENTE LE ISTRUZIONI PRIMA DI COMINCIARE L'ASSEMBLAGGIO

Cavo positivo: normalmente marrone o rosso
Cavo neutro: normalmente blu o nero
Cavo terra: normalmente verde o giallo

I LED in questo apparecchio non sono sostituibili; quando i LED raggiungono la fine della loro vita l'apparecchio intero dovrà essere sostituito.

DE Produkte mit elektronischen Vorschaltgeräten/ Treibern dürfen nicht im selben Stromkreislauf installiert werden wie Verbraucher mit induktiven Lasten, z.B. magnetische Leuchtstofflampen, Motoren oder Ventilatoren. Induktive Lasten können übermäßige Spannungsspitzen erzeugen, die elektronische Vorschaltgeräte beschädigen könnten.

LESEN SIE BITTE DIE ANWEISUNGEN SORGFÄLTIG DURCH, BEVOR SIE MIT DEM ZUSAMMENBAUEN BEGINNEN

Phase: Normalerweise Braun / Rot
Nulleiter: Normalerweise Blau / Schwarz
Erde: Normalerweise Grün / Gelb

Die Lichtquelle dieser Leuchte ist nicht austauschbar. Wenn die Lichtquelle das Ende ihres Lebenszyklus erreicht hat, muss die ganze Leuchte ersetzt werden.

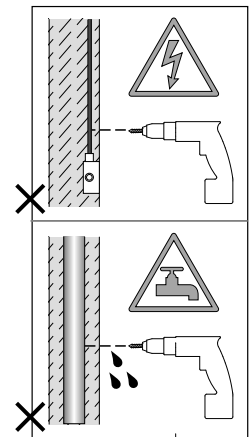

FOR WALL USE ONLY
Usage mural uniquement
Solo per uso a parete

Nur zur Verwendung als Wandleuchte

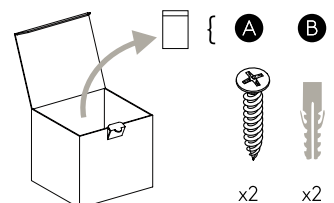
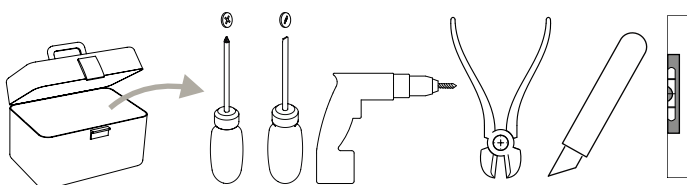

1

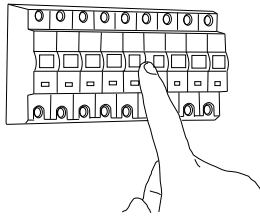

TURN OFF POWER
Couper Le Courant! / Strom Abshaken!
/ Corte La Corriente!

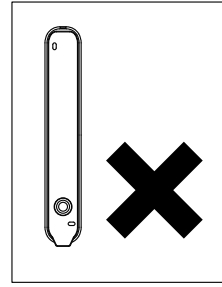
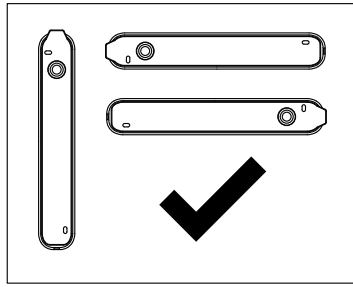

2

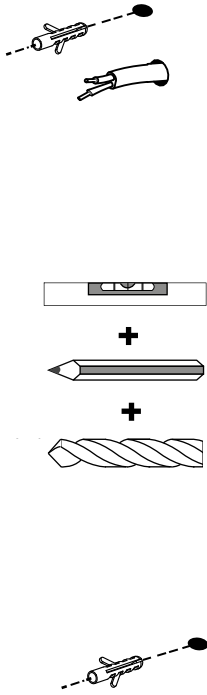

3

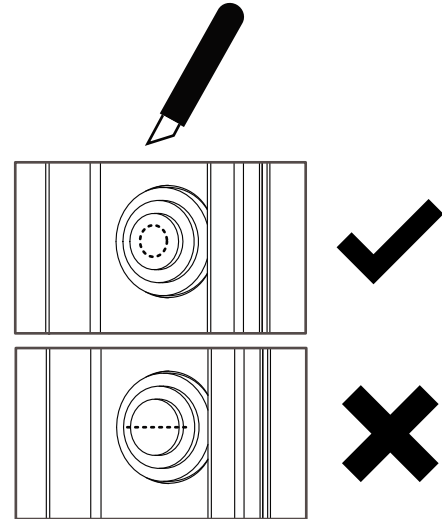
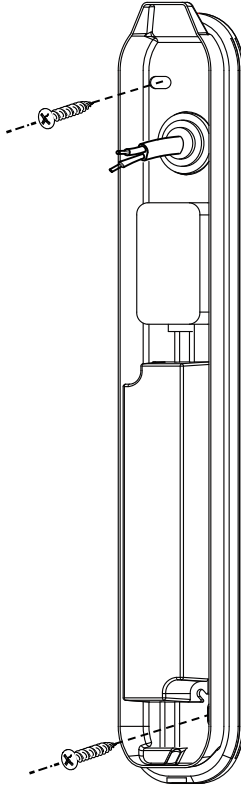

4a

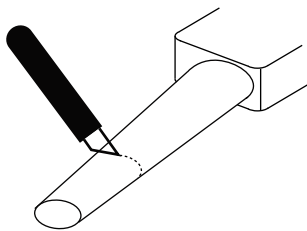

5a

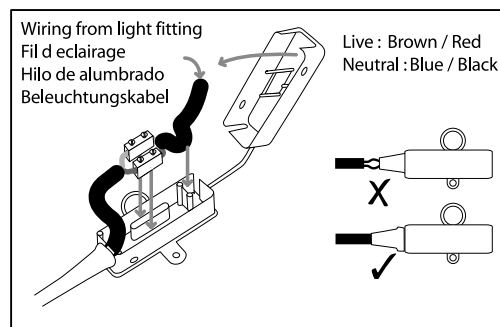

5b

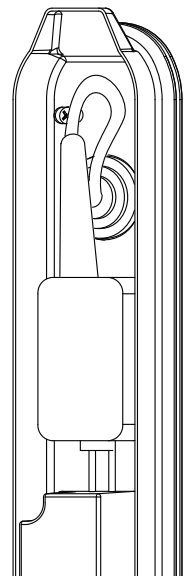

6

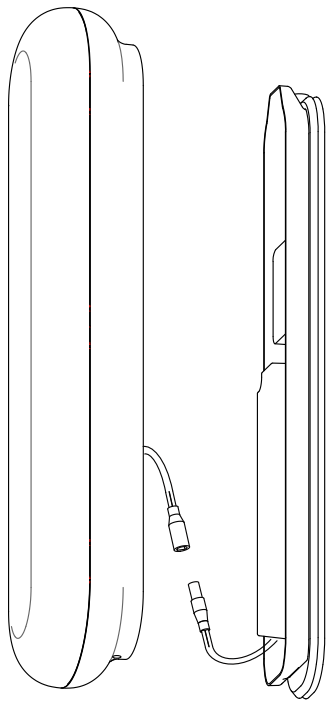

↓		ALTEA 360 (8014) X 1
↑		ALTEA 500 (8015) X 2

7

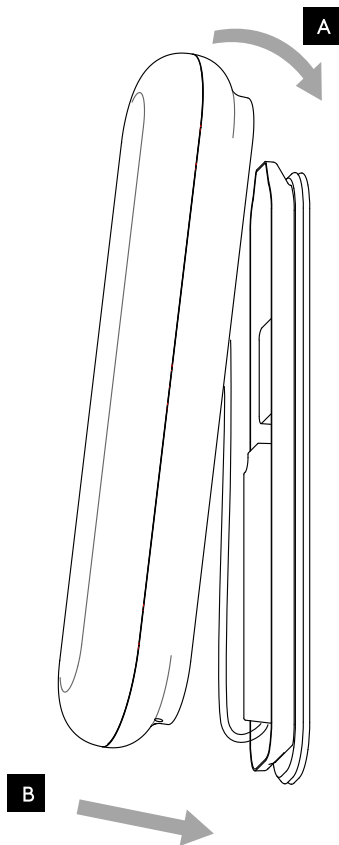

8

