

9

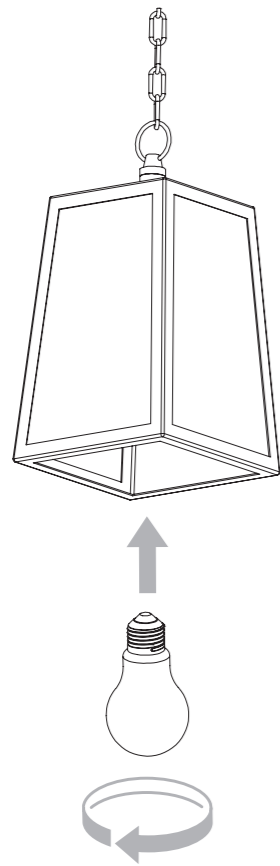

10



# CALVI PENDANT 305

astro

GB

PLEASE READ THE INSTRUCTIONS CAREFULLY  
BEFORE COMMENCING ASSEMBLY

Live: Normally Brown / Red  
Neutral: Normally Blue / Black  
Earth: Normally Green / Yellow

IT

LEGGERE ATTENTAMENTE LE ISTRUZIONI  
PRIMA DI COMINCIARE L'ASSEMBLAGGIO

Cavo positivo: normalmente marrone o rosso  
Cavo neutro: normalmente blu o nero  
Cavo terra: normalmente verde o giallo

FR

LIRE ATTENTIVEMENT LES INSTRUCTIONS  
AVANT DE COMMENCER LE MONTAGE

Phase: Normalement Brun / Rouge  
Neutre: Normalement Bleu / Noir  
Terre: Normalement Vert / Jaune

DE

LESEN SIE BITTE DIE ANWEISUNGEN  
SORGFÄLTIG DURCH, BEVOR SIE MIT DEM  
ZUSAMMENBAUEN BEGINNEN

Phase: Normalerweise Braun / Rot  
Nulleiter: Normalerweise Blau / Schwarz  
Erde: Normalerweise Grün / Gelb

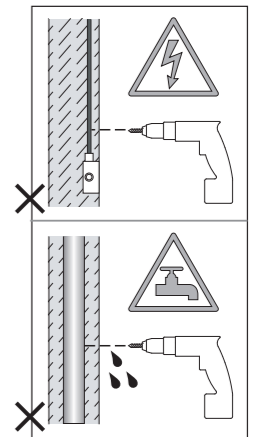

**GB** If the external cord of this luminaire is damaged, it must be replaced by the manufacturer or a qualified person.

**FR** Si le câble externe est endommagé, il doit être remplacé par le fabricant ou par une personne agréée.

**DE** Wenn das externe Netzkabel beschädigt ist, muss es durch den Hersteller oder eine ähnlich qualifizierte Person ersetzt werden.

**IT** Se il cavo esterno è danneggiato, deve essere sostituito dal costruttore o da personale qualificato.

**ESP** Si el cable exterior está dañado, debe ser sustituido por el fabricante o una persona cualificada.

**SWE** Om den externa sladden är skadad måste den bytas ut av tillverkaren eller en kvalificerad person.

**POL** Uszkodzony przewód zewnętrzny musi wymienić producent lub wykwalifikowana osoba.

**FIN** Jos ulkoinen johto on vaurioitunut, valmistajan tai pätevän henkilön on vaihdettava se.

Y



FOR CEILING USE ONLY

Seulement pour montage au plafond  
Da utilizzarsi solo al soffitto  
Nur für den Deckengebrauch

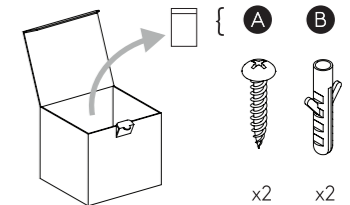
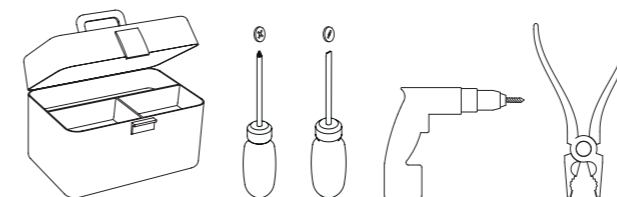

x2 x2

1

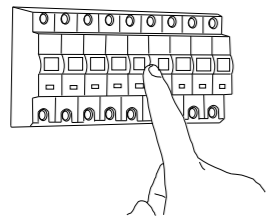

TURN OFF POWER  
Couper le courant! /  
Spegner la corrente! /  
Strom Abhalten!

2

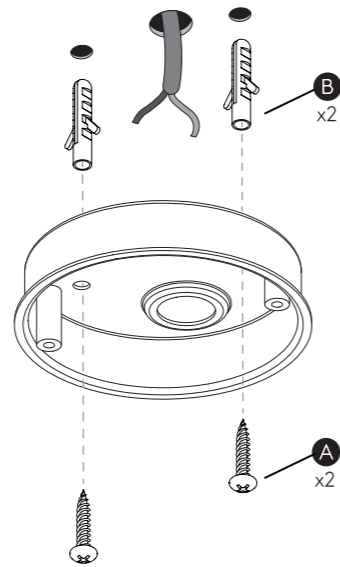

3

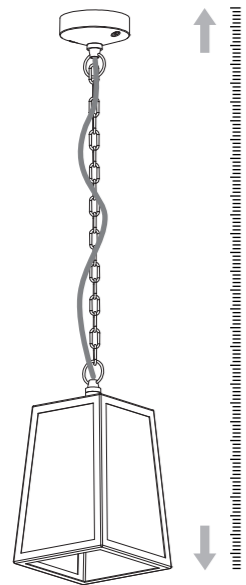

MAX  
2160  
mm

4

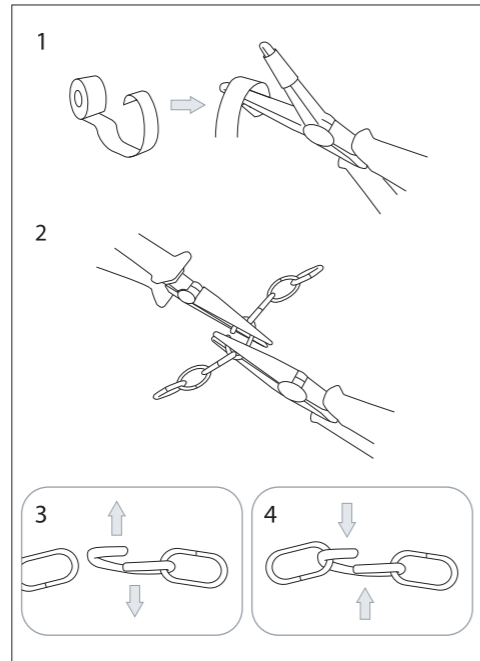

5

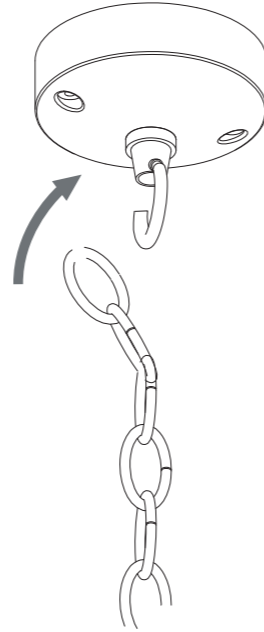

7

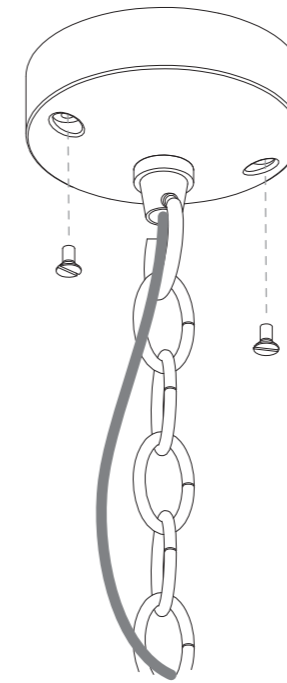

8a

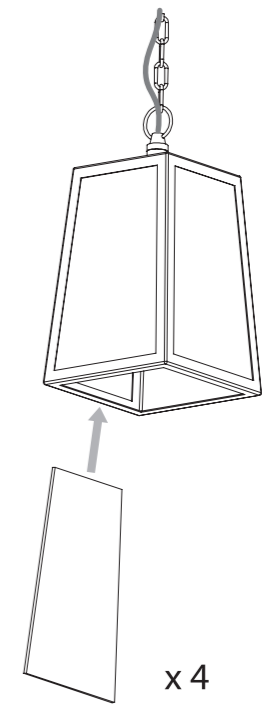

8b

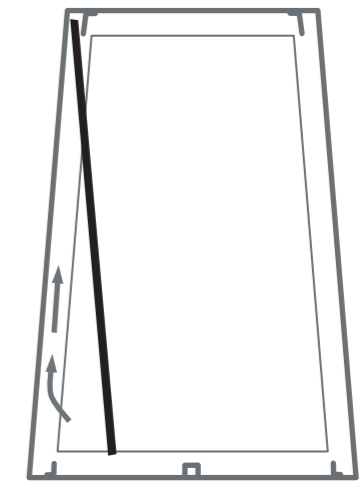
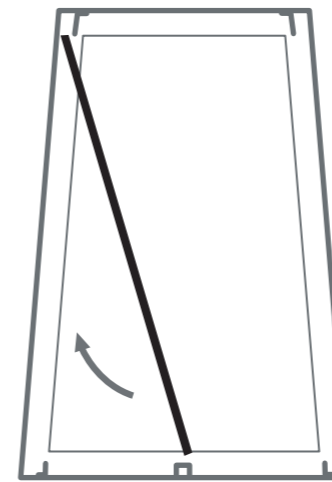

6a

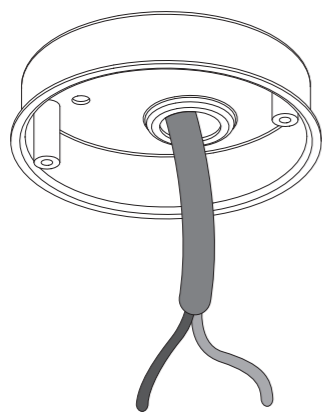

6b

WIRING FROM PRODUCT /  
Fil de produit /  
Cavo dal prodotto /  
Beleuchtungskabel

